

Article number: 20276B48MZ2SW

Description: E+G Swivel clamp connector
GN276-B48-MZ-2-SW

Measures

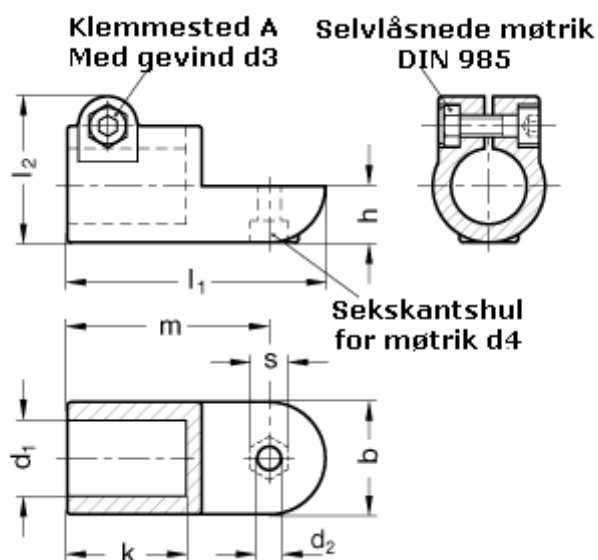

$b = 65$	$m = 115$
$d_1 = B48$	$s = 17$
$d_2 = 10.2$	
$d_3 = M10$	
$d_4 = M10$	
$k = 74.0$	
$l_1 = 148$	
$l_2 = 77.5$	